

3/

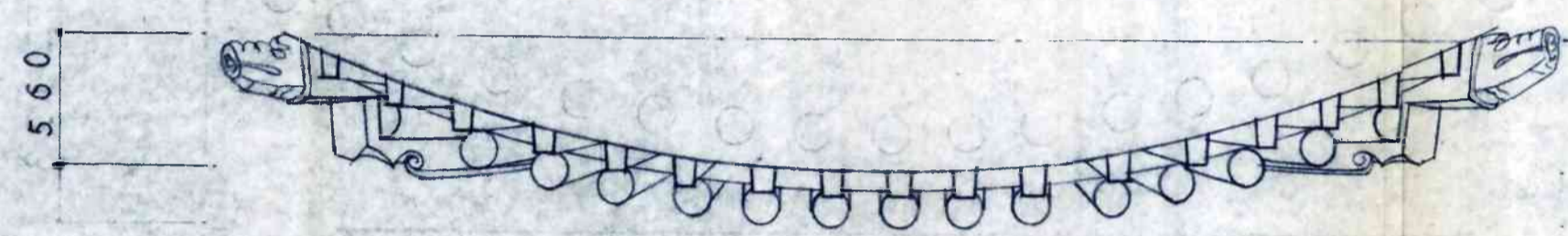

3 층 앙곡 상세도
SCALE = 1/30

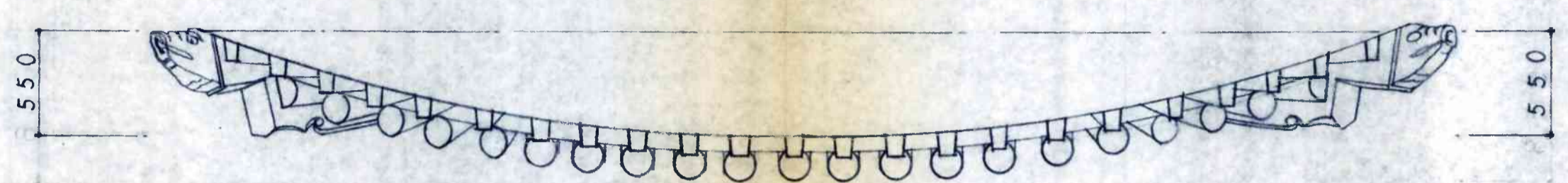

2 층 앙곡 상세도
SCALE = 1/30

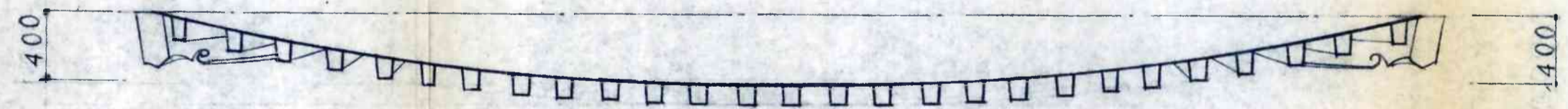

1 층 앙곡 상세도
SCALE = 1/30

NOTE _____



YEAGREEN ARCHITECTS
 22-4262 예그린건축연구소

상세 3/	제도	검도	축척 1/30	일자 198	일련번호	도면번호 031
				공사명	도면명	
				연구단 해체 복원공사	각층 앙곡 상세도 0033	

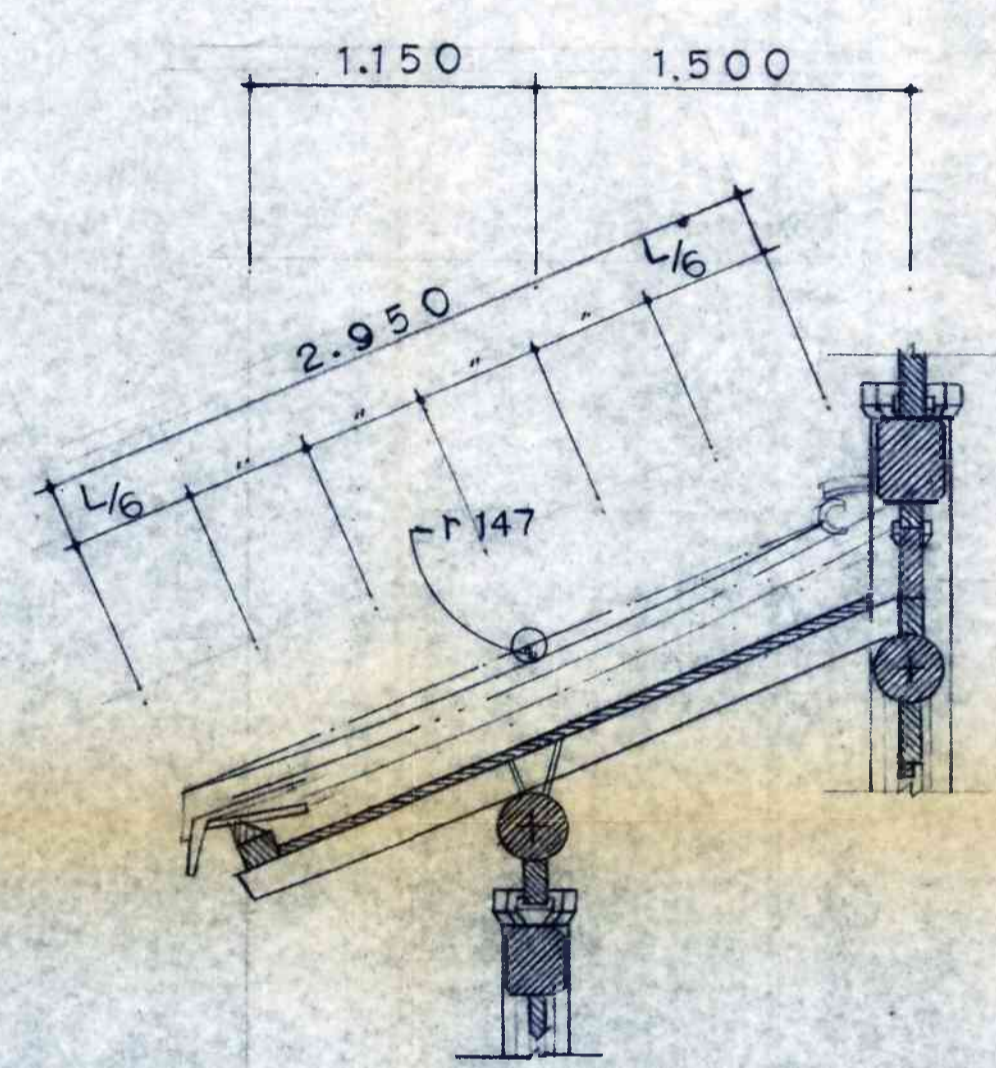

1 층 지붕 기와곡상세도
 축척: 1/30

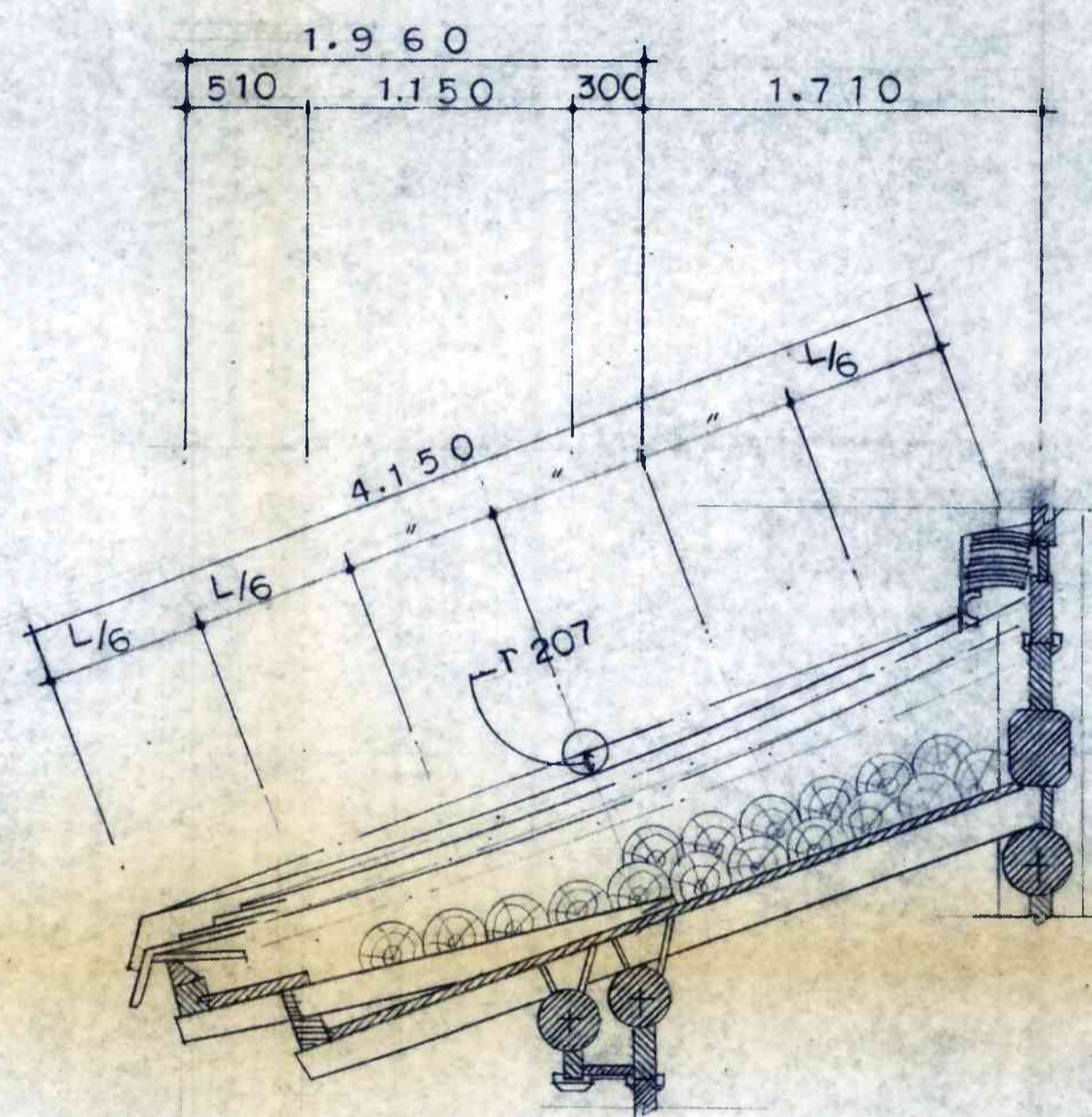

2 층 지붕 기와곡상세도
 축척: 1/30

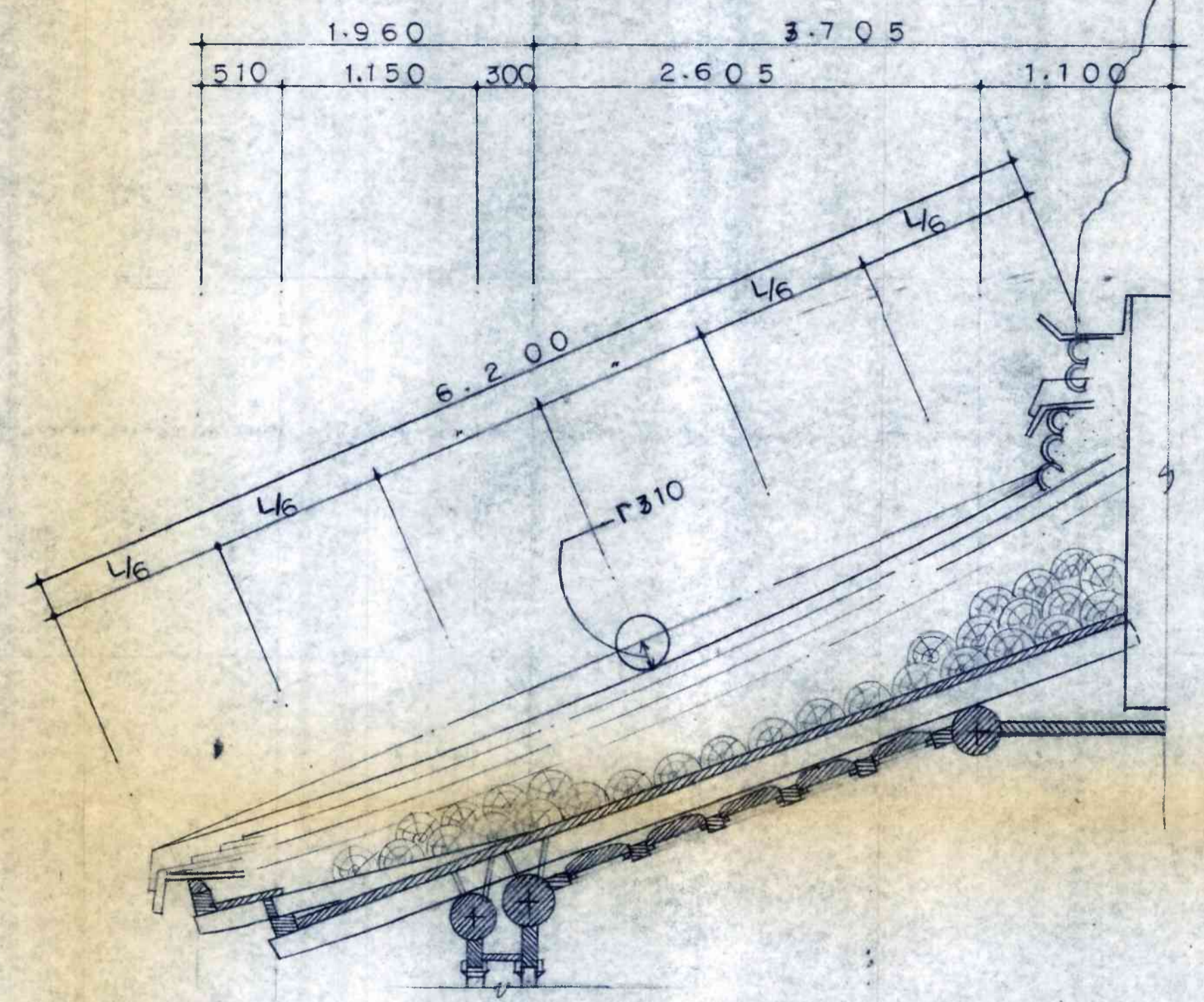

3 층 지붕 기와곡상세도
 축척: 1/30

NOTE



설계 리 제도 리 검토 _____ 축척 1/30
 YEAGREEN ARCHITECTS 예그린건축연구소
 ☎ 22-4262

말자 _____ 일련번호 _____ 도면번호 032
 회사명 _____ 도면명 0034
 연구원 리재원공사 123층기와곡상세도

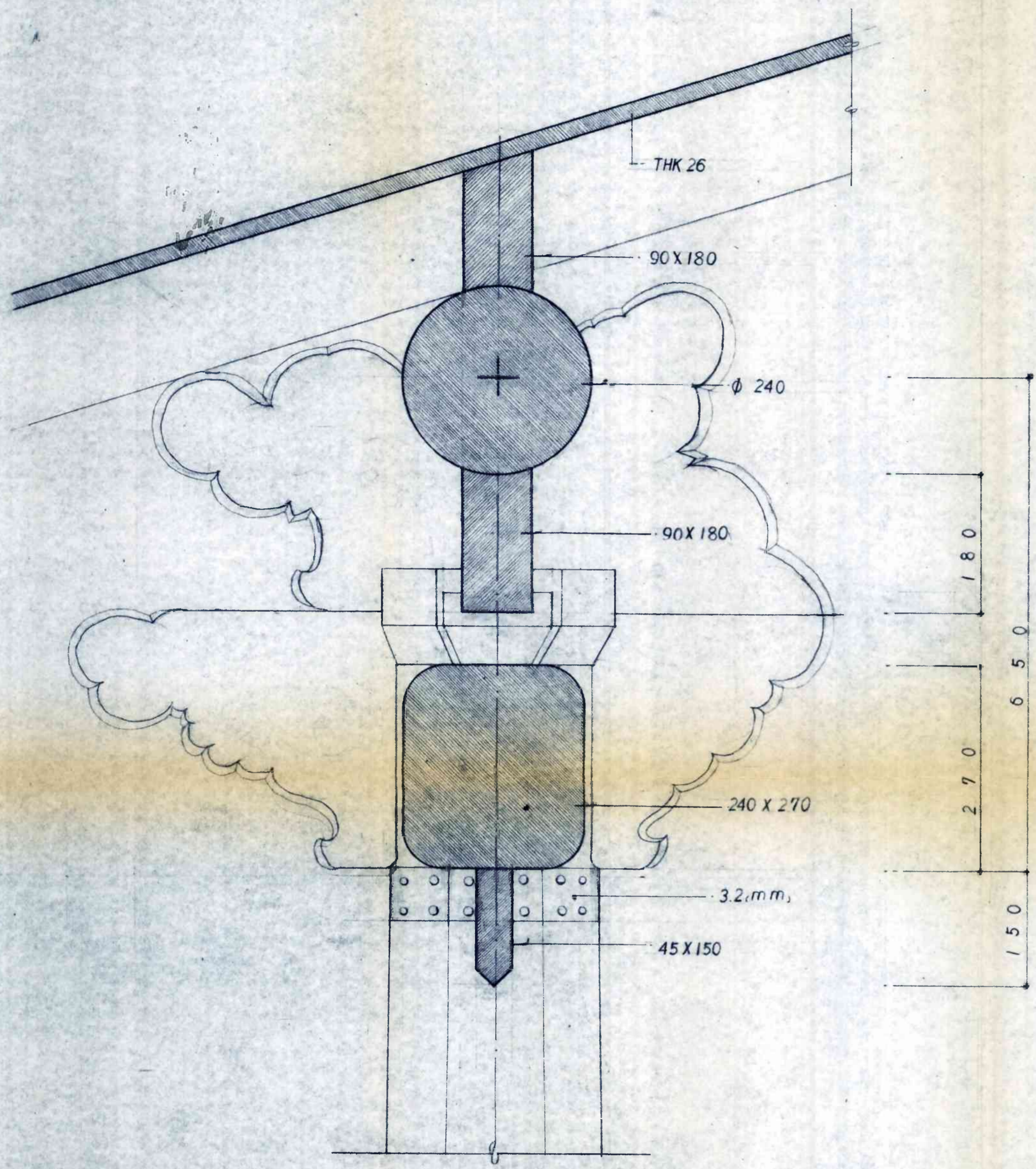

1
A233
1층 운공 상세도
SCALE = 1/5

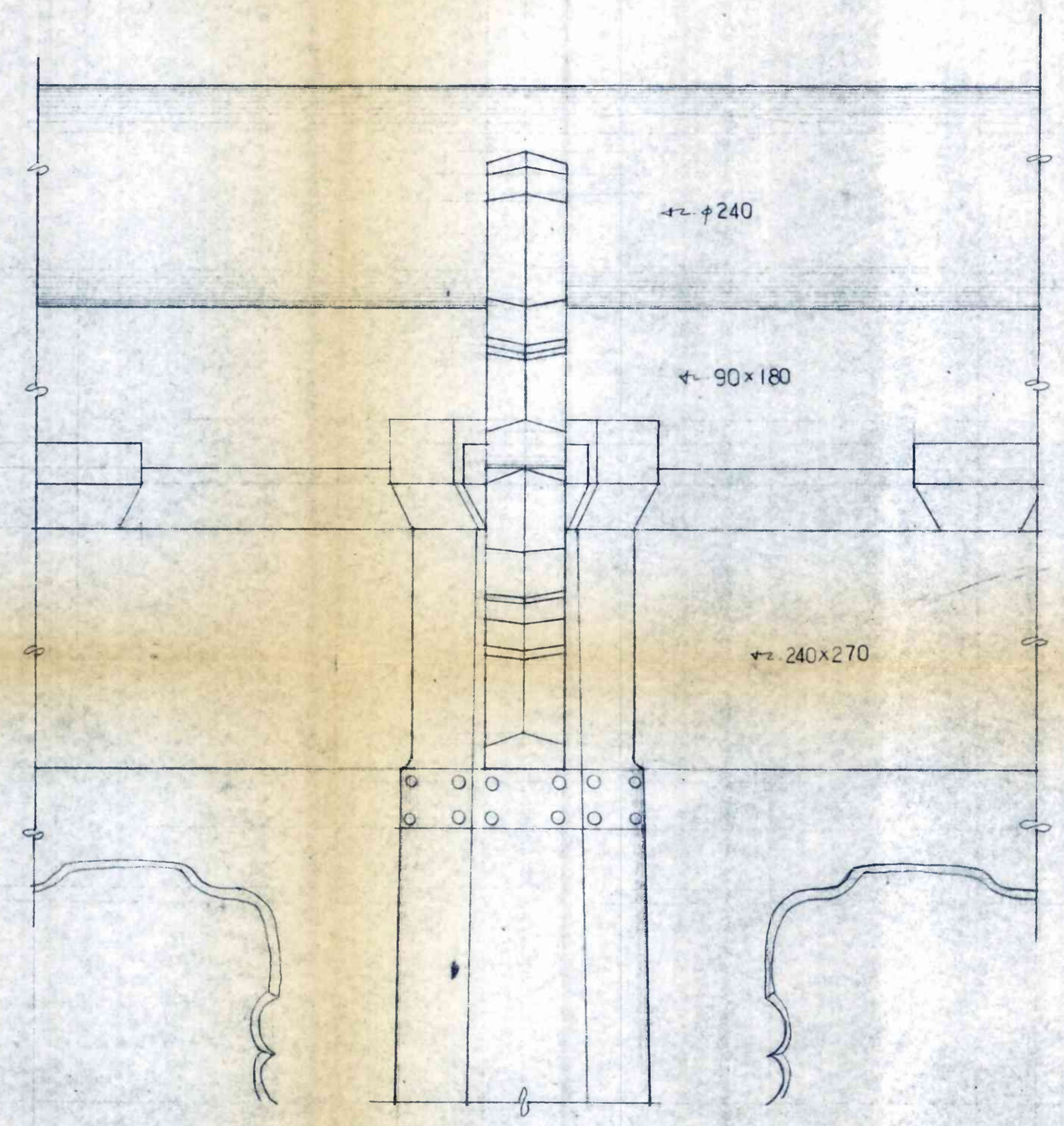

2
A233
1층 운공 상세도
SCALE = 1/5

NOTE



YEAGREEN ARCHITECTS
22-4262

예그린건축연구소

설계: [Signature]
제도: [Signature]
감도: [Signature]
축척: 1/5
일자: _____
공사명: 연구관 해체 복원 공사

도면번호: 033
도면명: 운공 상세도
0035

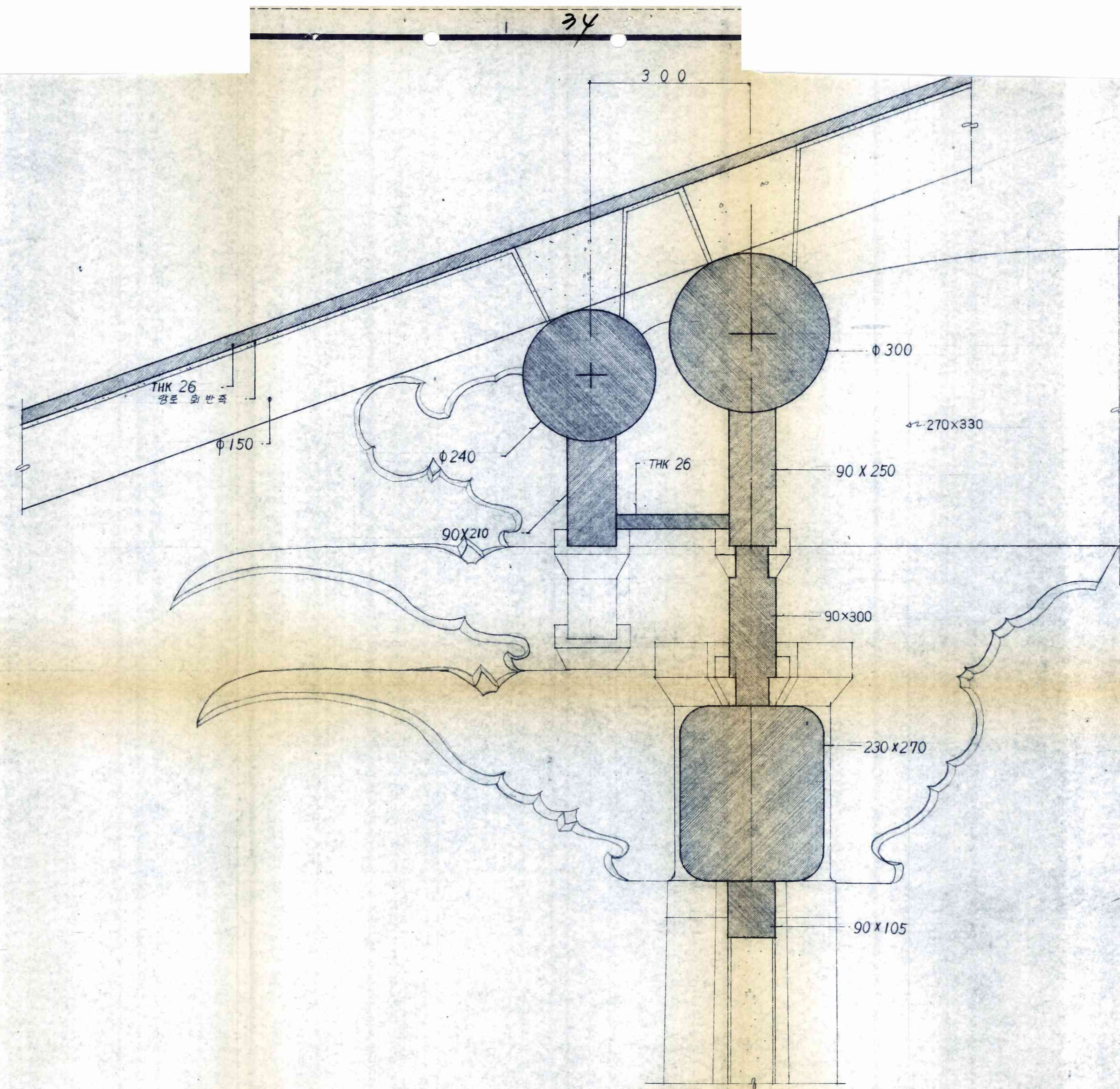

2층 이약공 상세도
SCALE = 1:5

NOTE

상기	제도	검도	축척	1/5	일자	1987	도면번호	034
YEAGREEN ARCHITECTS 22-4262					회사명	연구안 해체 복원 공사	도면명	이약 상세도 0036

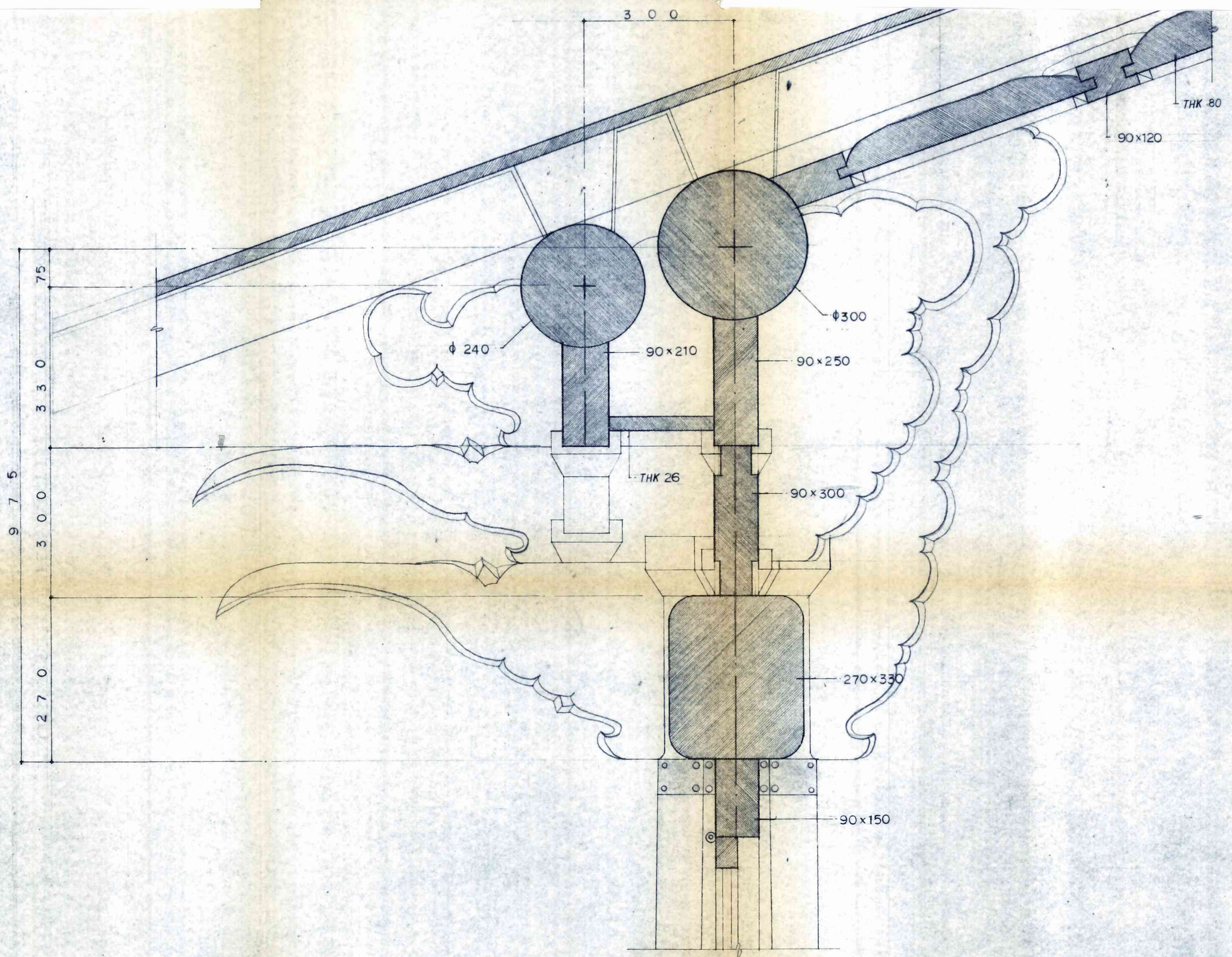

3층 이익공 상세도
 SCALE = 1/5

NOTE

 YEAGREEN ARCHITECTS T 22-4262	설계 <i>김</i> 제도 검토 수직 1/5	일자 1981.1 공사명	입면번호 도면번호 035 도면명
	예그린건축연구소		

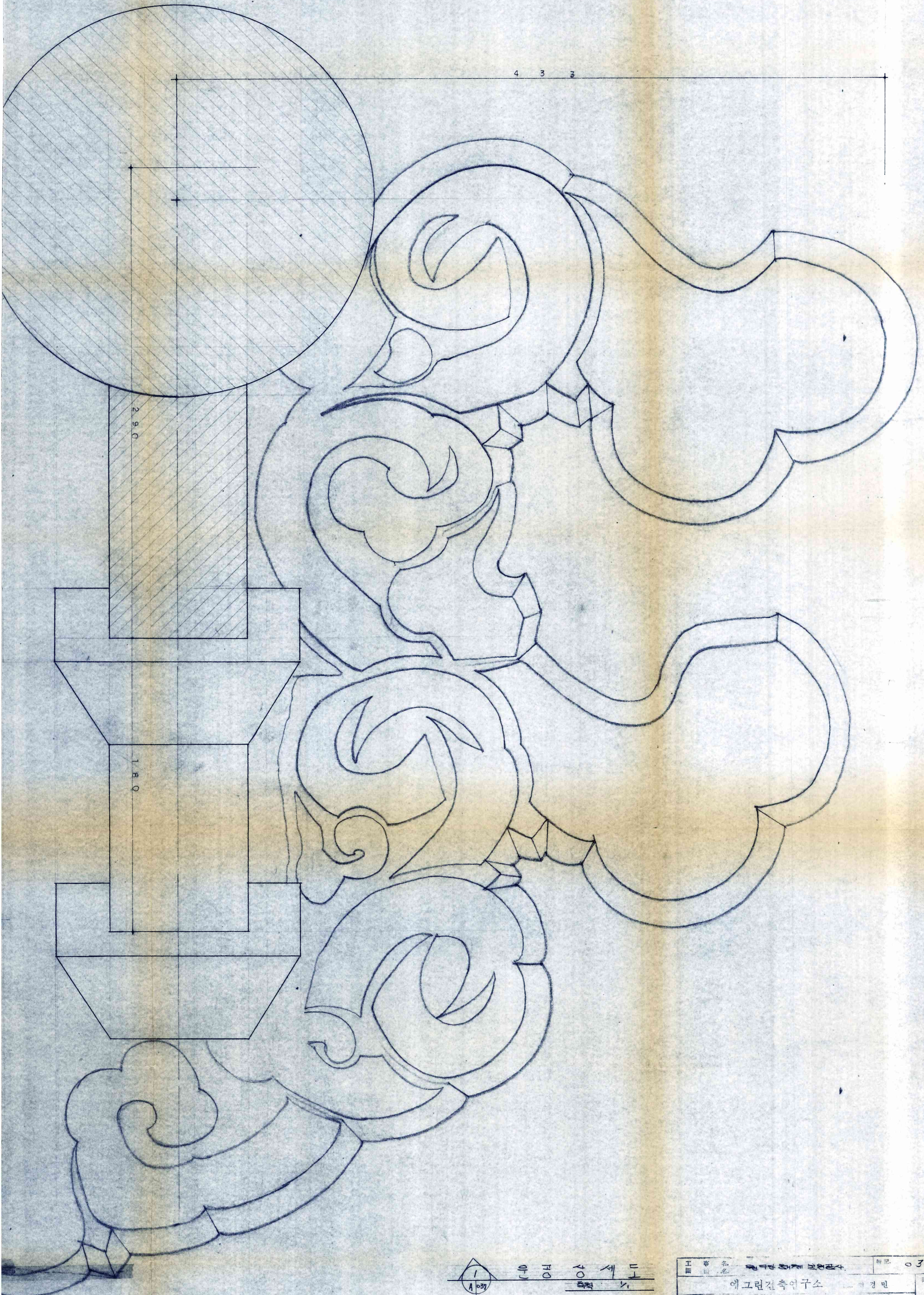

工 号 名	特 記	037
工 圖 名	이그린건축연구소	이경민
完 成 年 月	1 /	設 計 監 理

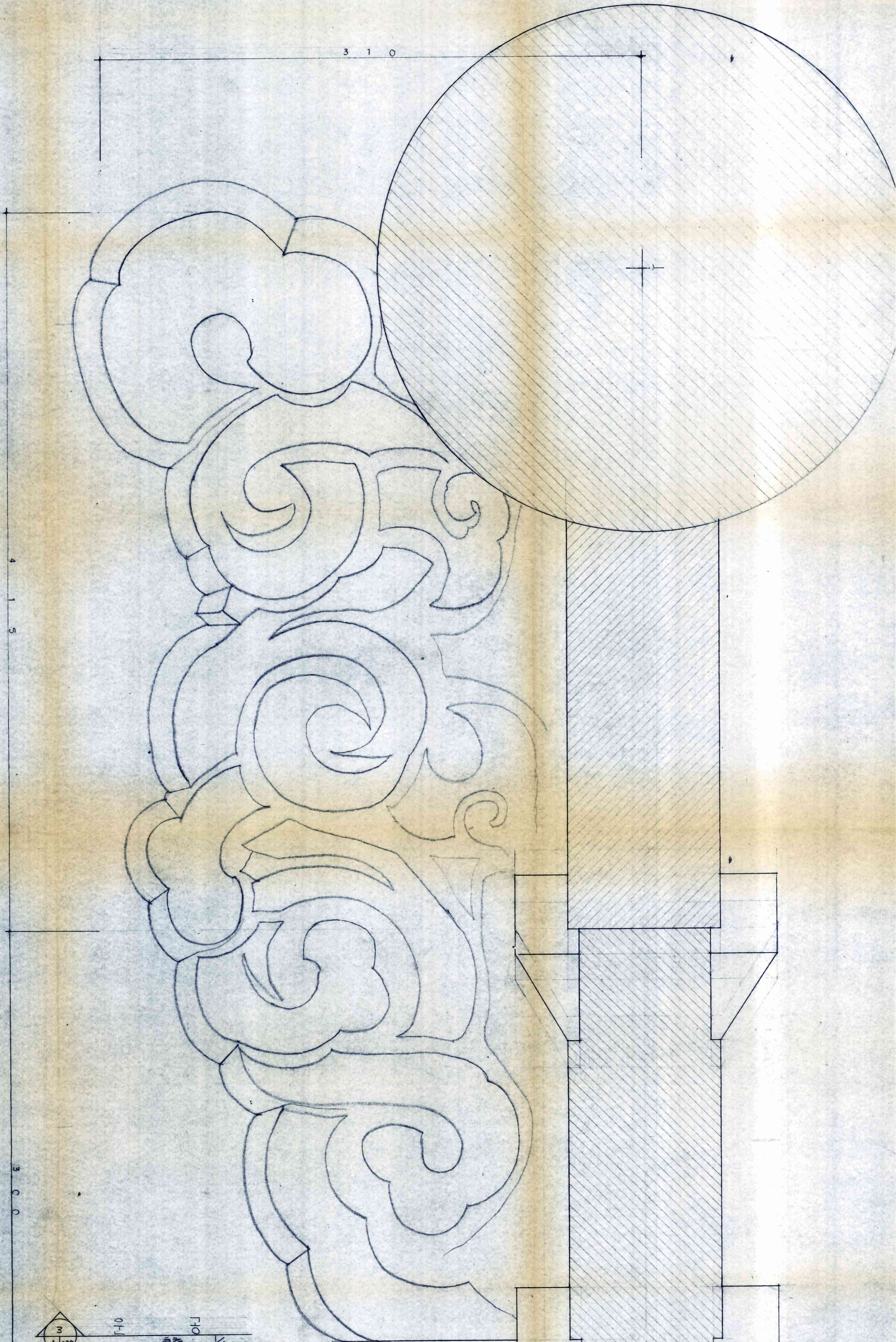

3
A 039

工 号	039
工 名	에그린진속인구스
製 法	X
製 者	
製 年	
製 月	
製 日	

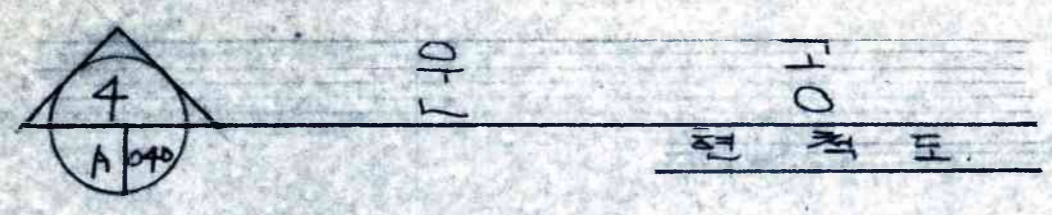
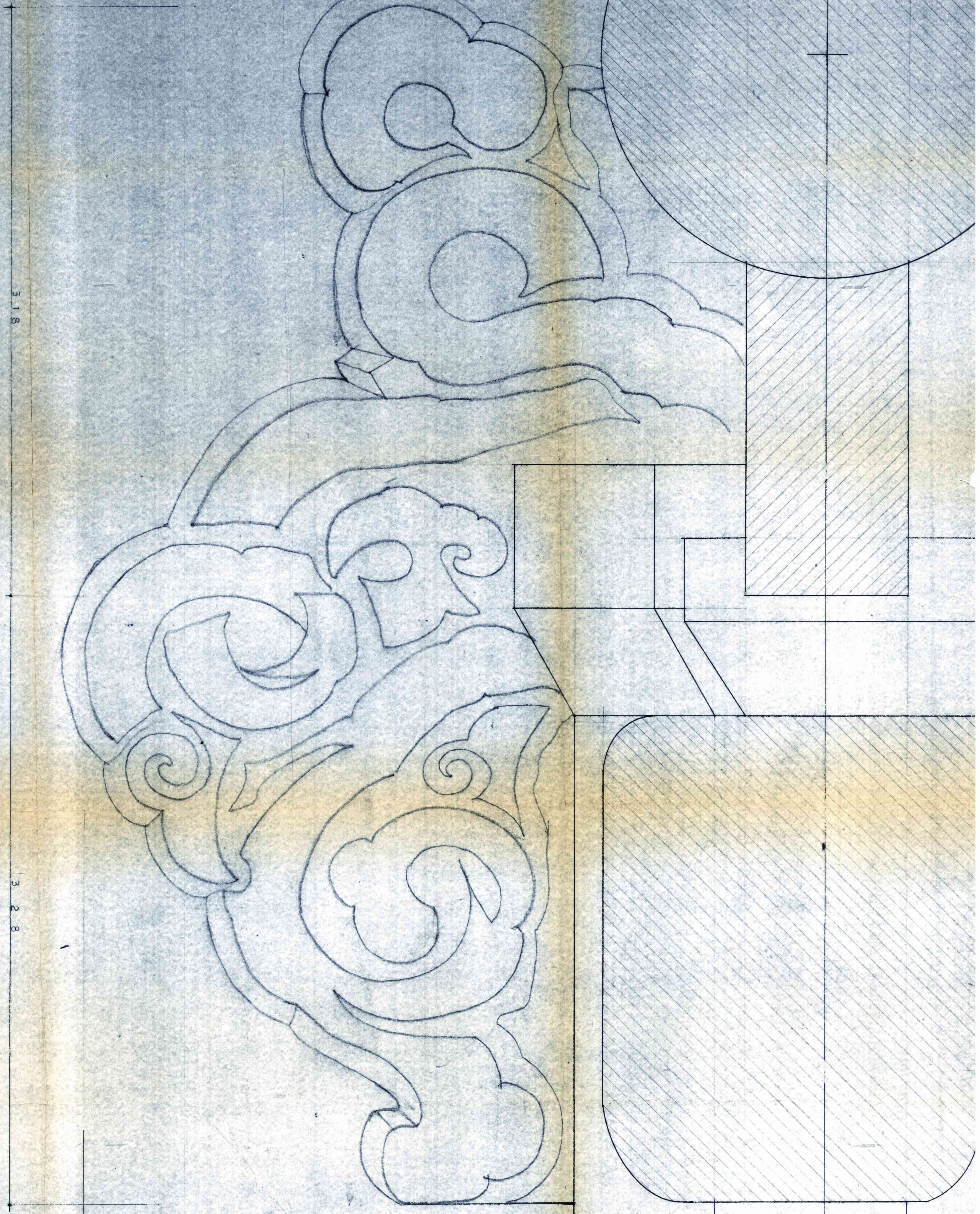

工 名	조각공예연구소	제 도	040
제 도	조각공예연구소	대 리 인	정민
제 도	1/1	제 도	정민

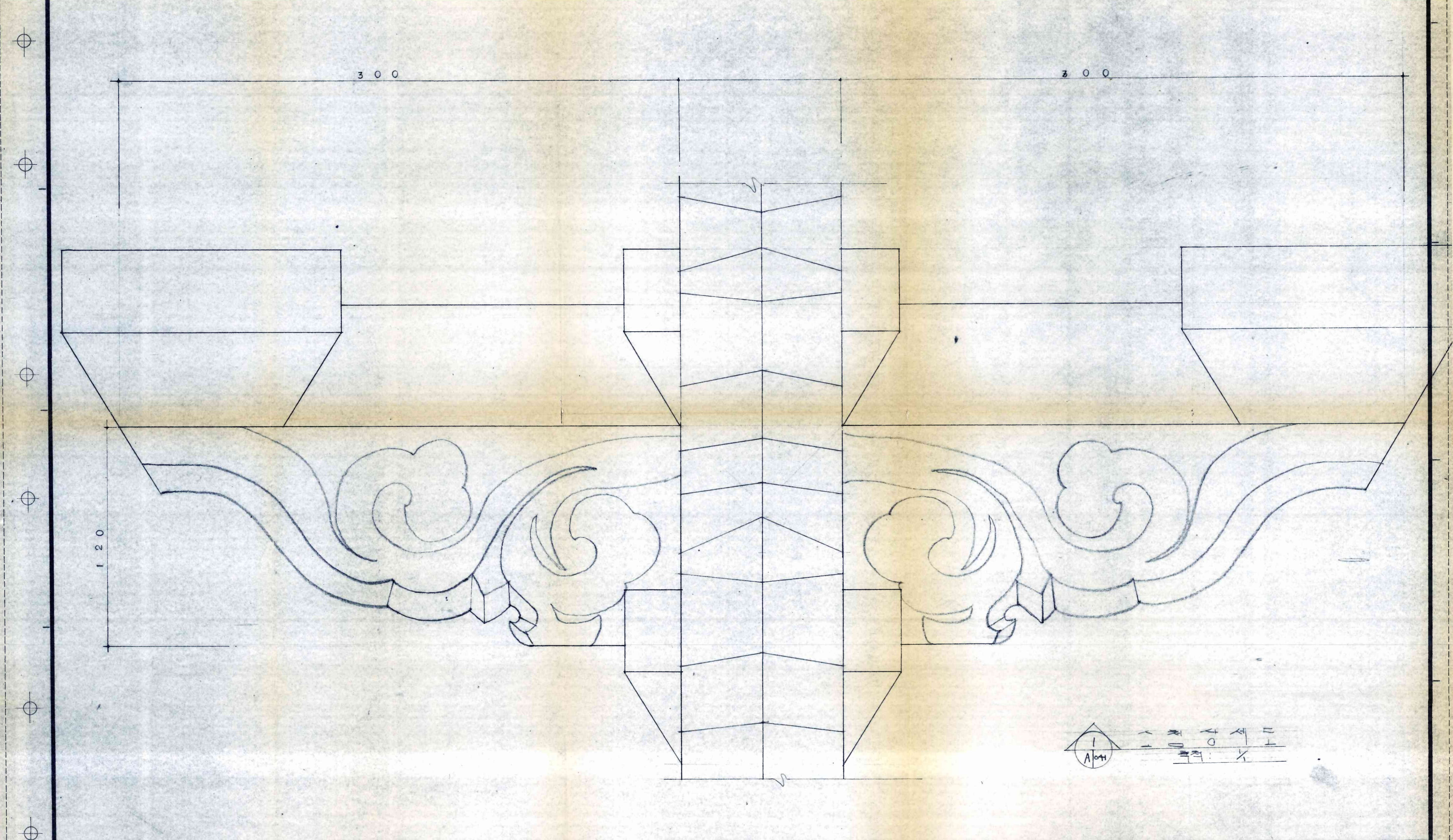

NOTE



YEAGREEN
ARCHITECTS
☎ 22-4262

예그린건축연구소

공사명
연구단 건축계획연구소

도면번호
041

도면명
다경 일서도

0043

43

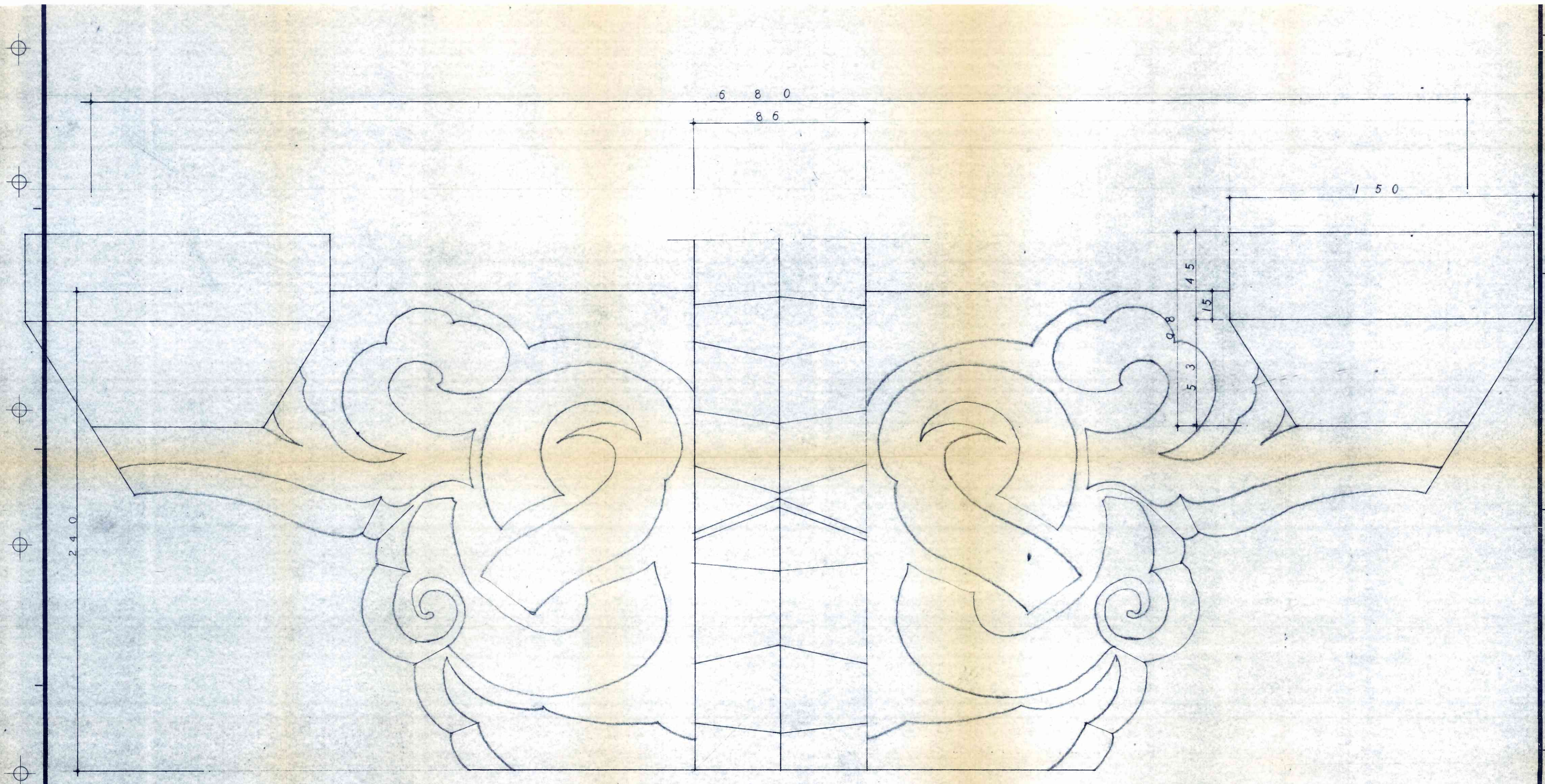

1 내부 화반 검차 상세도
A/B/C
현 착 도

NOTE

 YEAGREEN ARCHITECTS 22-4262	설계 <i>[Signature]</i> 제도 <i>[Signature]</i> 검토 축척 1/1	일자 공사명 연구단지내 복원공사	일련번호 도면번호 042 도면명 내부화반검차 상세도
	예그린건축연구소		042 0044

[Handwritten Signature]

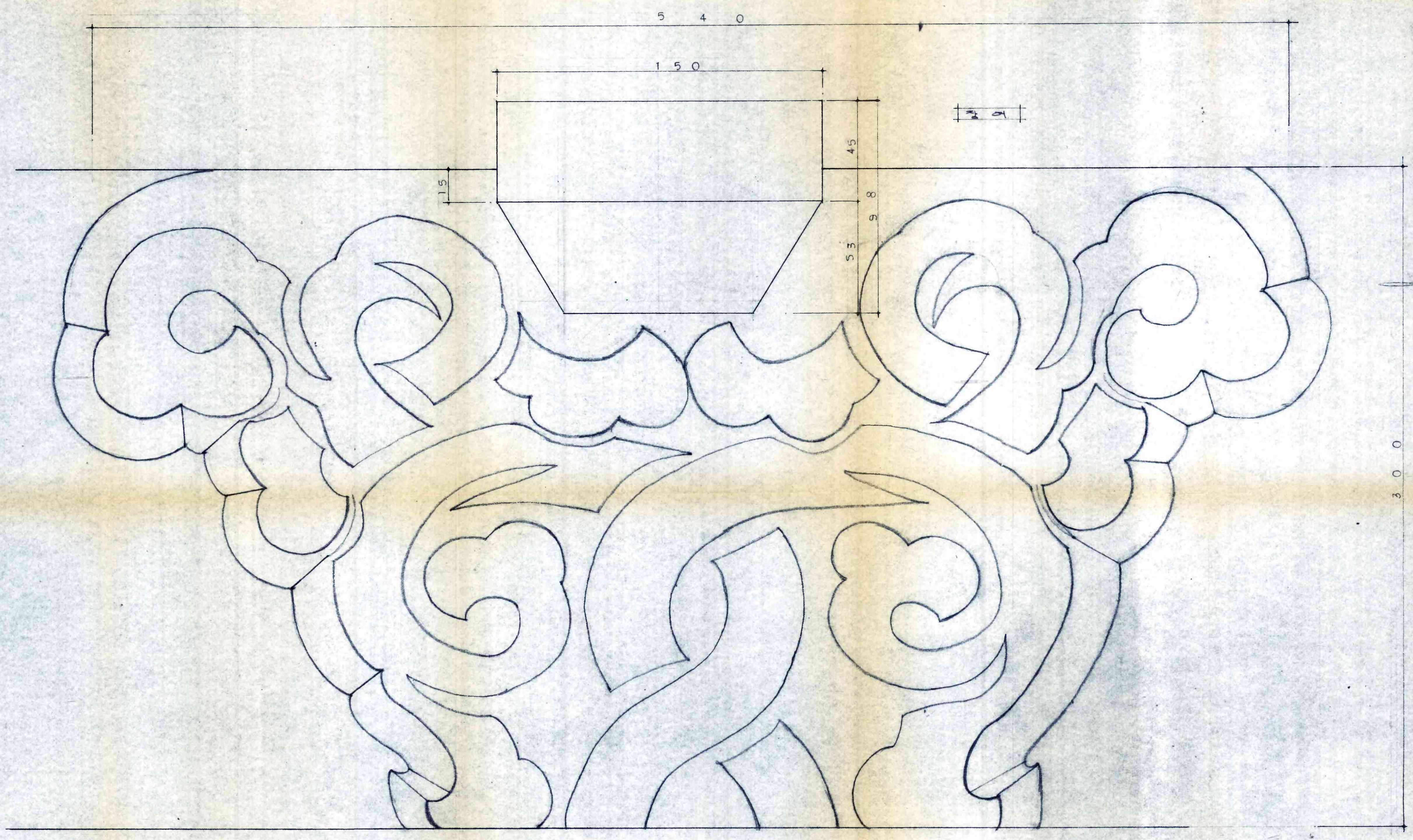

1
A-33
화
축척: 1/100

NOTE

 YEAGREEN ARCHITECTS T 22-4262	24 21	제도	1/100	축척	1/100	일련번호	도면번호 043
	예그린건축연구소				공·사·명	도면명	0045

45

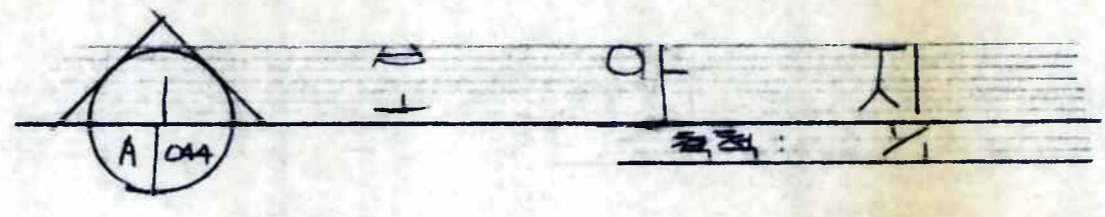
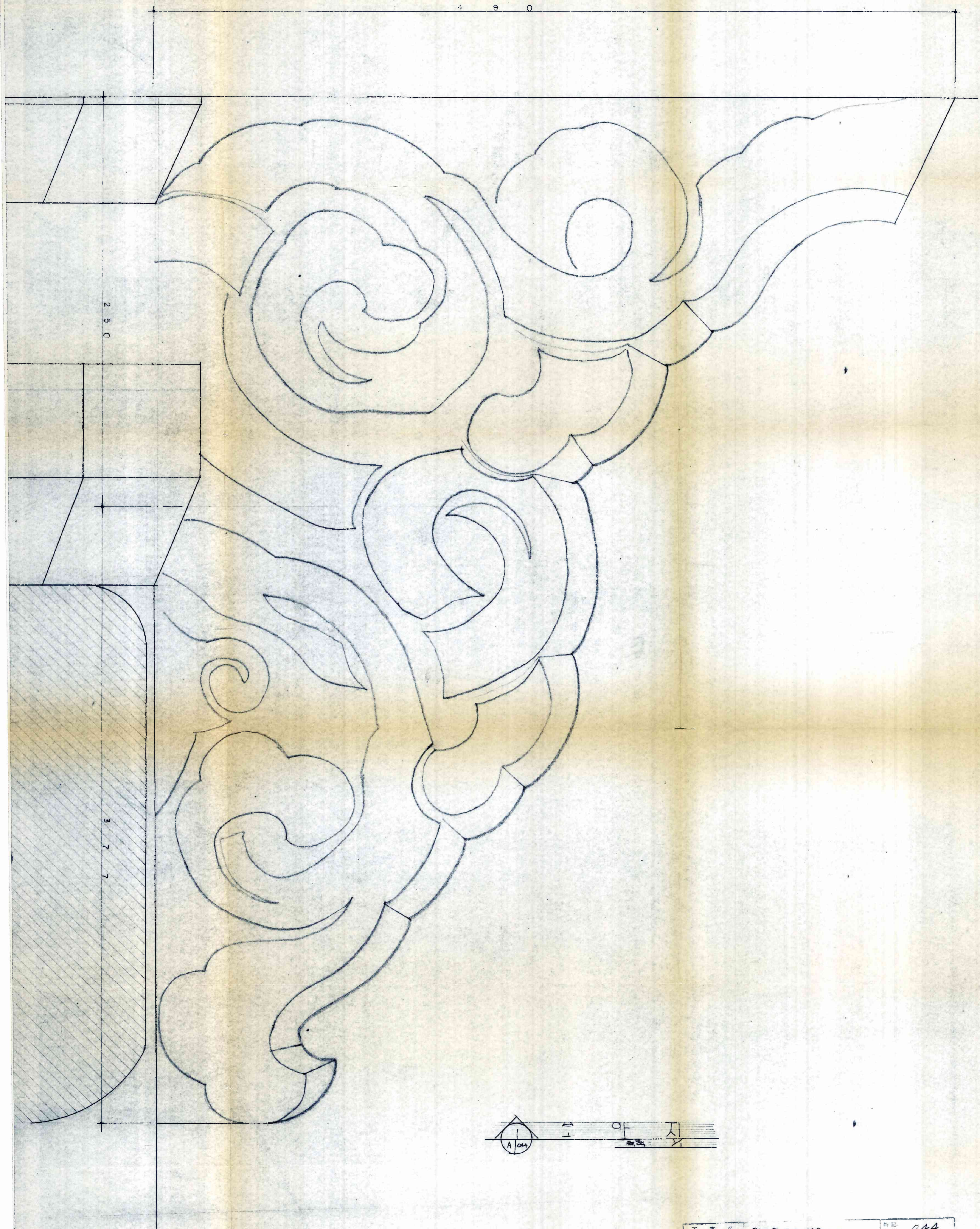

工 種	名 稱	원구단 장식목판공구	特 記	044
製 作 年 月	設 計 者	에그린건축연구소	監 理	정민
		X		

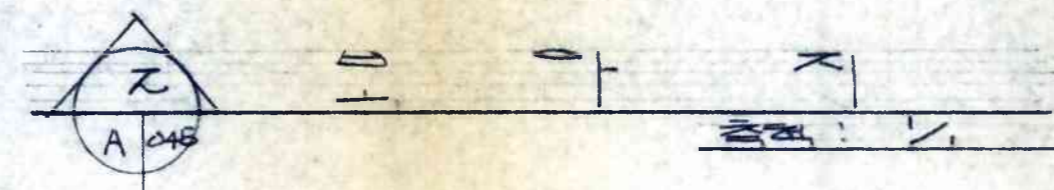
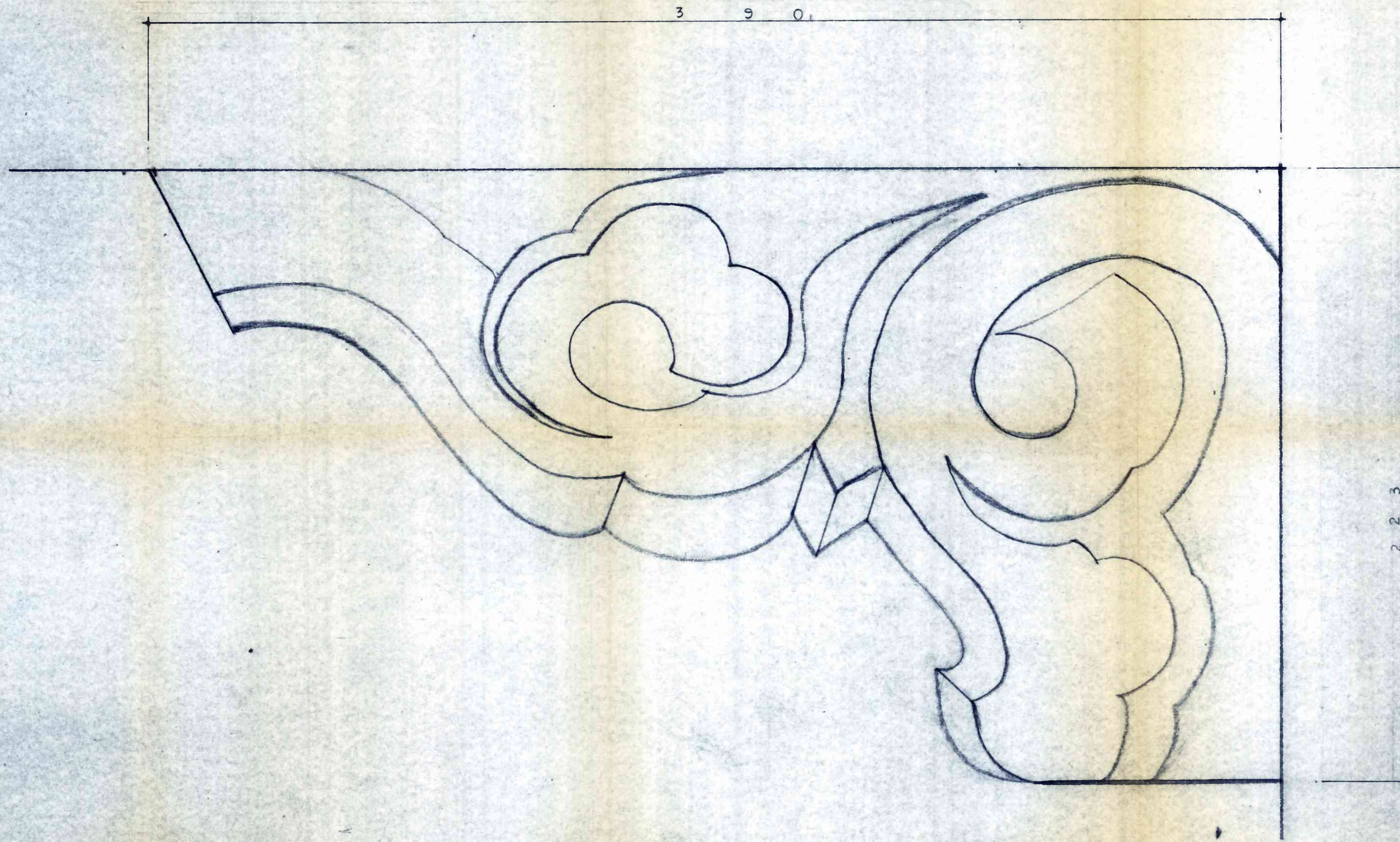

NOTE _____



상세 *김* 제도 *김* 감도 _____ 축척 1/1
 YEAGREEN ARCHITECTS 예그린건축연구소
 ☎ 22-4262

설자 _____ 일련번호 _____
 공사명 _____
 연구개발연구소

도면번호 045
 도면명 _____
 0047

67

시드 42934

연구실 87세 복원공사

(4901)

1981

67

